

The logo for Blink Medical features the word "blink" in a bold, white, lowercase sans-serif font. A small gold dot is positioned above the letter "i". To the right of "blink", the word "medical" is written in a gold, lowercase sans-serif font. Below "blink" and "medical", the tagline "the single-use instrument company" is written in a smaller, gold, lowercase sans-serif font. The background consists of concentric, overlapping circles in various shades of blue, creating a sense of depth and motion.

**blink** medical  
the single-use instrument company

the single-use instrument company

[www.blinkmedical.com](http://www.blinkmedical.com)

## Welcome

Blink Medical is one of the world's largest manufacturers of quality, sterile, single use surgical instruments and bespoke instrument sets and packs. We supply instruments from our UK headquarters, to both NHS and private sector hospitals for use in either theatres or out patient departments. Through our exclusive distributor network, we export to over 20 countries worldwide including Australia, New Zealand and throughout continental Europe.

Offering the highest quality instruments, we provide products for Ophthalmic, Dermatology, Plastic Surgery, Cosmetic Surgery and ENT departments. More recently we have also introduced a wider range of Bi Polar Forceps and we have increased the range of standard off the shelf packs.

Since launching in 2004, our primary objective has been to supply the highest quality surgical instruments, in conjunction with first class customer service. Our high standards and attention to detail are reflected throughout the company, beginning with our manufacturing sites which adhere to ISO13485:2016, through to quality inspection, packaging, sterilisation, and the onward supply to the end user.

If you require any further information please call our customer service team on +44 121 386 8433. Alternatively to view our extensive product range visit us at [www.blinkmedical.com](http://www.blinkmedical.com) to see why we are known as...

*"the single use instrument company".*

**blink**medical  
the single-use instrument company



[www.blinkmedical.com](http://www.blinkmedical.com)



## Manufacturing Facility

All Blink Medical's surgical instruments are manufactured to the highest standard. Each of our manufacturing sites are ISO accredited and audited regularly to ensure compliance. All instruments undergo stringent inspection and cleaning protocols before being shipped to our state of the art distribution centre.



## Logistics

Our UK Logistics Centre handles thousands of shipments every year, sending consignments to the UK and around the world. Whether ordering one box of forceps or a large consignment of customised sets, our highly trained professional staff are here to ensure your shipment is expertly handled and delivered on time.



## UK Quality Control

Our UK based quality control department is staffed by fully trained and experienced associates, who undertake the inspection of all instruments in accordance with the requirements of our ISO13485:2016 accredited Quality Management System.

All instruments are subject to stringent inspection in accordance with their intended use in a safe and effective manner. Only instruments meeting the acceptance criteria can be subsequently released for final packaging operations.

All instruments and procedure packs are assembled within a validated 'Class 8' cleanroom, with subsequent sterilisation of the packaged products completed ensuring sterility is achieved and maintained in accordance with the relevant regulatory requirements.

All production processes are subject to appropriate quality assurance control procedures ensuring that all product and regulatory requirements are met on a perpetual basis.

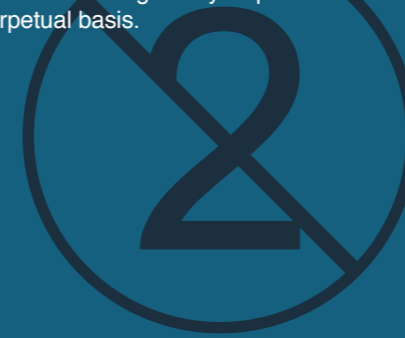

## Customer Service

Our customer service department will handle your order professionally and courteously, expediting it in a timely fashion. Should you have a query or require a quotation, our friendly, helpful staff will aim to deal with your request politely and quickly. Where possible we will process any quotation for a bespoke set the same day.



## Internationally Available

Our exclusive International Distributor network covers the majority of Europe, Australia and New Zealand. Our main distributors carry the Ophthalmic range of instruments, however some also now carry the Cosmetic, ENT and Dermatology lines as well. Should you represent a company interested in becoming a Blink Distributor or alternatively if you are a potential customer wishing to locate your nearest Blink distributor, please visit our website at [www.blinkmedical.com](http://www.blinkmedical.com) and click on the appropriate tab.





**10-1415 - Forceps Birks Suture Tying**  
8mm Tying Platform, O/L 110mm



**10-1302 - Forceps Utility Lister**  
1:2 Teeth 0.8mm with 6mm Tying Platform, O/L 114mm



**10-1203 - Forceps St Martins**  
1:2 Teeth 0.6mm, O/L 90mm



**10-1204 - Forceps St Martins**  
1:2 Teeth 0.3mm, O/L 90mm

**11-6009 - Forceps Max Fine Curved Tying**  
Smooth Tip 6mm Tying Platform, O/L 110mm



**10-1104 - Forceps Bonn**  
1:2 Teeth, 0.8mm with 6mm Tying Platform, O/L 82mm

**10-1105 - Forceps Bonn**  
1:2 Teeth, 0.12mm with 6mm Tying Platform, O/L 82mm

**10-1106 - Forceps Bonn Micro**  
1:2 Teeth, Typing Platform 6mm, O/L 105mm



**10-9007 - Forceps Tying McPhearson**  
Straight Plain Tip 6mm Tying Platform O/L 85mm



**10-9008 - Forceps Tying McPhearson**  
Straight Plain Tip 6mm Tying Platform O/L 110mm



**10-8008 - Forceps Hoskins Straight Notched**  
0.5mm Notch 5mm Tying Platform O/L 90mm

**10-8009 - Forceps Hoskins Micro Notched**  
0.12mm Notch 5mm Tying Platform



**11-7009 - Forceps Pierse Collibri Notched**  
0.3mm Notch O/L 85mm



**11-7010 - Forceps Collibri Toothed**  
1:2 Teeth 0.8mm Tooth O/L 65mm



**11-7011 - Forceps Collibri Toothed**  
1:2 Teeth 0.8mm Tooth O/L 110mm

**11-6010 - Forceps Tying Kelman McPhearson**  
8mm Tying Platform O/L 85mm



**10-1205 - Forceps Barraquer Fixation**  
9:10 Teeth, O/L 103mm





**11-5011 - Forceps Capsulorhexis Inamura**

Flat Handle  
Cross Action  
45 Degree Shaft  
0.4mm Sharp Tip  
O/L 105mm



**11-5020 - Forceps Capsulorhexis Inamura**

Round Handle  
Cross Action  
Curved Shaft  
0.4mm Sharp Tip  
O/L 105mm



**11-5013 - Forceps Capsulorhexis Utrata**

Round Handle  
Direct Action  
Curved Shaft  
0.4mm Sharp Tip  
O/L 103mm



**11-5012 - Forceps Capsulorhexis Utrata**

Round Handle  
Direct Action  
45 Degree Shaft  
0.4mm Sharp Tip  
O/L 103mm



**11-5021 - Forceps Capsulorhexis Inamura**

Flat Handle  
Cross Action  
Curved Shaft  
0.4mm Sharp Tip  
O/L 105mm



**11-5022 - Forceps Capsulorhexis Utrata**

Flat Handle  
Direct Action  
45 Degree Shaft  
0.4mm Sharp Tip  
O/L 105mm



**11-5023 - Forceps Capsulorhexis Micro Incision 1.8mm**

Direct Action  
Curved Shaft  
0.4mm Sharp Tip  
OL 97mm



**11-5027 - Forceps Capsulorhexis Micro Incision 1.8mm**

Direct Action  
45 Degree Shaft  
0.4mm Sharp Tip  
O/L 97mm



**11-5024 - Forceps Capsulorhexis Utrata Curved**

Flat Handle  
Direct Action  
Curved Shaft  
0.4mm Sharp Tip  
O/L 105mm



**11-5025 - Forceps Capsulorhexis Fulcher**

Flat Handle  
Direct Action  
Curved Shaft  
0.4mm Rounded Tip  
O/L 105mm



After listening to our customers and discussions with our quality, planning and production teams, we are now packaging our Capsulorhexis Forceps in rigid blister packs.



**10-1300 - Forceps Epilation**  
Angled Tips  
O/L 91mm



**10-1301 - Forceps Suture Moorfields**  
16mm Serrated Tying Platform  
O/L 107mm



**20-7001 - Scissors Iris Straight**  
Rounded Tip O/L 100mm



**20-7002 - Scissors Iris Straight**  
Sharp Tip O/L 100mm



**10-1311 - Forceps Suture Moorfields Utility**  
14mm Serrated Tying Platform  
O/L 107mm



**11-1005 - Forceps Mosquito Curved**  
Curved Tip  
O/L 100mm



**20-6003 - Scissors Vannas Straight**  
O/L 95mm



**21-6004 - Scissors Vannas Curved**  
O/L 95mm



**10-1006 - Forceps Mosquito Straight**  
O/L 100mm



**20-4006 - Scissors Westcott Straight**  
Standard Tip O/L 120mm



**20-4007 - Scissors Westcott Straight**  
Sharp Tip O/L 120mm





**21-4008 - Scissors Westcott Curved**  
Sharp Tip O/L 120mm

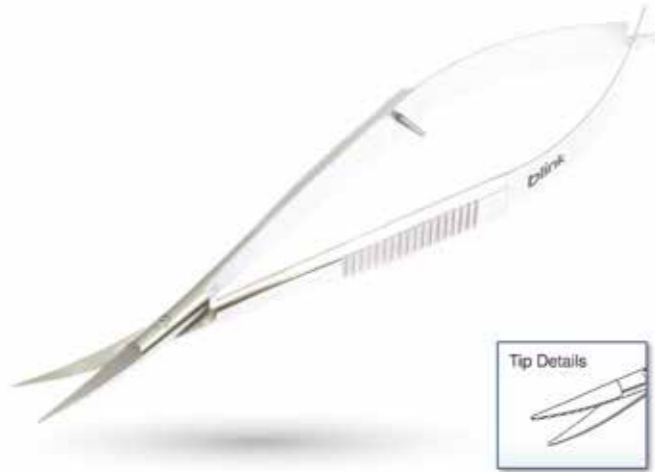

**21-4009 - Scissors Westcott Curved**  
Standard Tip O/L 120mm

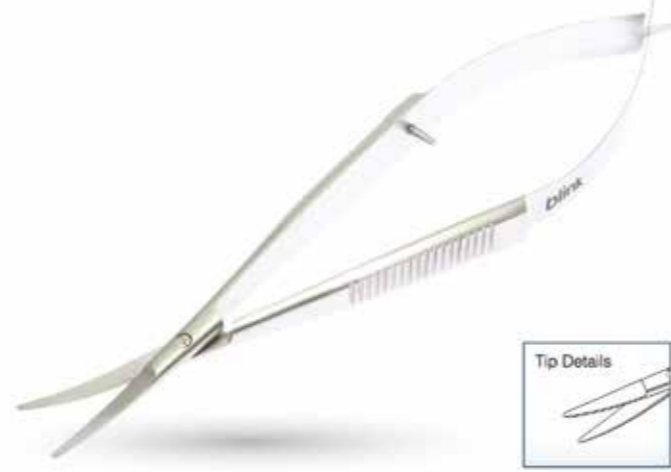

**21-4010 - Scissors Westcott Curved**  
Fine Tip O/L 120mm



**21-5001 - Scissors Westcott Curved Small**  
Sharp Tip O/L 100mm

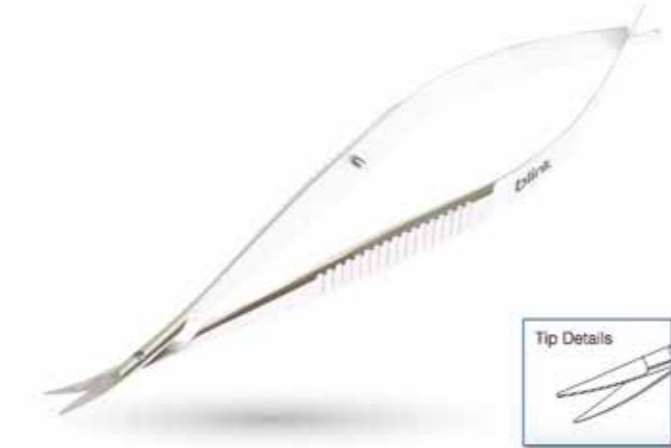

**21-3010 - Scissors Ong**  
Sharp Tip O/L 92mm



**21-4011 - Scissors Dolphin Nose**  
Dolphin Tip O/L 120mm



## Do you perform Sub Tenon's Anaesthesia?

- > The NEW Conjunctival Probe™, a cost effective alternative to Westcott Scissors. The first dedicated instrument for making precise Sub Tenon incisions.
- > "The Conjunctival Probe™ would appear to be a safe and effective way of puncturing the conjunctiva to access the sub-Tenons space. It clearly appears to cause less conjunctiva trauma than Westcott scissors thereby minimising risk of conjunctival complications and reducing reflux of local anaesthetic"

*Ophthalmic Anaesthesia Journal article June 2018*

New



## Introducing the New SISTA™ Technique Small Incision Sub Tenon Anaesthesia...

> The new **SISTA™** technique using the revolutionary conjunctival probe for small incision sub tenon anaesthesia

> **3** Keeping the probe in contact with the sclera, follow the curve of the globe for approximately 1cm.

> **1** Raise the Conjunctiva using a pair of non-toothed Moorfields forceps, holding them at 90 degrees to the direction of the Probe.

> **4** Withdraw the probe but maintain the grip on the Conjunctiva with the forceps.

> **2** Holding the probe parallel to the surface of the sclera, puncture the Conjunctiva.

> **5** Insert the Sub Tenon Cannula to inject the anaesthetic in the usual manner.

**30-4000 - Speculum Barraquer**  
Solid Blade Angled Temporal L40mm W42mm

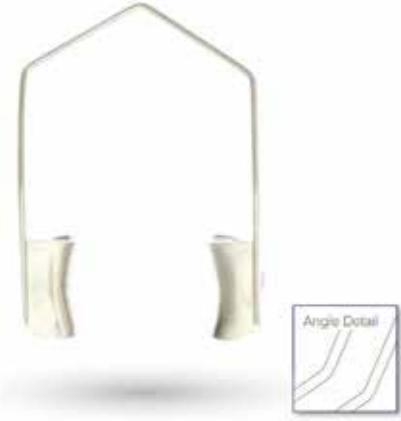

**30-4001 - Speculum Adjustable**  
Sliding Angled Temporal L45mm

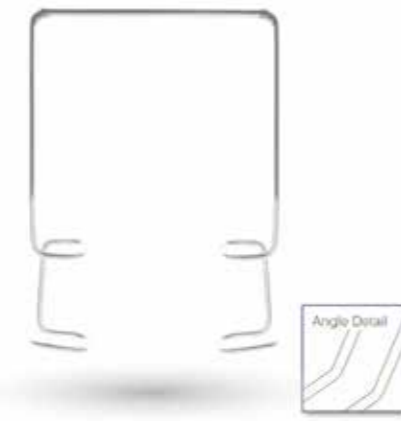

**30-3001 - Speculum Burratto**  
Straight L57mm



**31-2003 - Speculum Barraquer**  
Angled Temporal L40mm W30mm

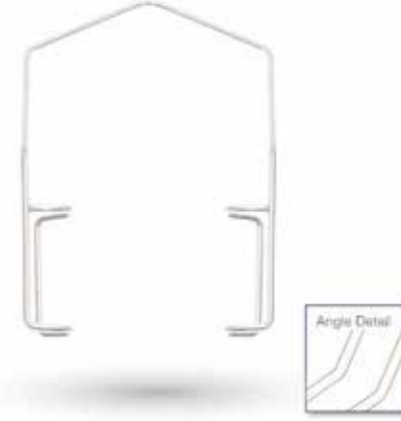

**30-2004 - Speculum Barraquer Straight**  
L40mm W30mm



**31-1006 - Speculum Kratz-Barraquer**  
Angled Temporal L40mm W30mm

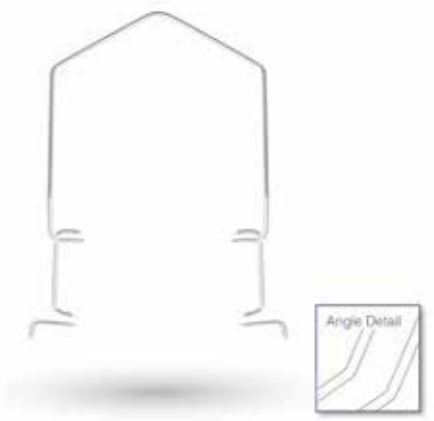

**30-3002 - Speculum Paediatric Spring**  
Solid Blade 7mm O/L35mm L30mm W30mm



**31-3003 - Speculum Cook Adjustable**  
Solid Blades L40mm



**31-3004 - Speculum Clarkes**  
Angled Temporal L80mm



**30-1007 - Speculum Kratz-Barraquer**  
Straight L40mm W30mm



Temporal



Straight

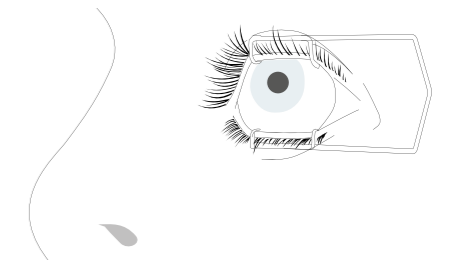

**31-3100 - Speculum Neo Natal**  
Angled Temporal W21mm O/L34mm

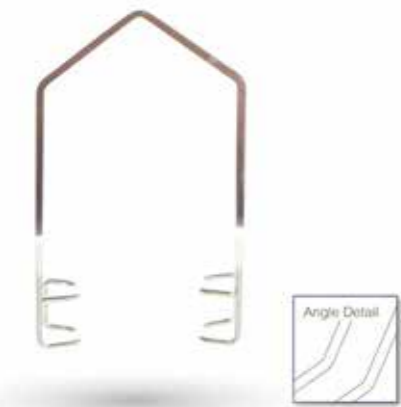

**31-3101 - Speculum Neo Natal**  
Strong Spring Angled Temporal  
W21mm O/L34mm

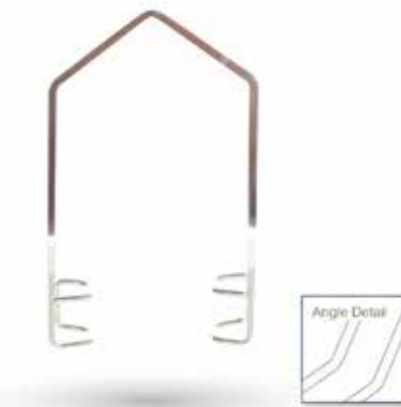

**31-3002 - Speculum Leibinger**  
Angled Temporal O/L65mm



**31-3000 - Solid Blade Leibinger Speculum**  
Angled Temporal O/L 65mm







**40-5002 - Manipulator Lens Hook Sinskey Straight**  
Tip L 0.5mm O/L 124mm

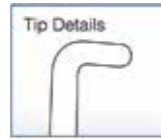

**41-5001 - Manipulator Lens Hook Sinskey Angled**  
Tip Angled at 45 Degrees  
Tip L 0.5mm O/L 120mm

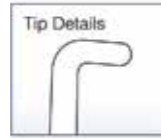

**41-3004 - Manipulator Spatula**  
Tip Angled at 45 Degrees  
Tip L 12mm W0.75mm O/L 135mm

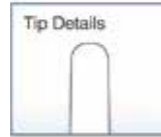

**41-3005 - Neuhann Spatula**  
Tip Angled at 45 Degrees  
Tip Curved Angled



**41-2005 - Rotator Nucleus Y Shaped**  
On horizontal axis  
Tip Angled at 45 Degrees  
Tip L 10mm O/L 124mm



**41-2006 - Rotator Nucleus Y Shaped**  
On vertical axis  
Tip Angled at 45 Degrees  
Tip L 10mm O/L 124mm



**41-1006 - Lester IOL Manipulator**  
Tip Angled at 45 Degrees  
Tip L 12mm 1mm Branch O/L 125mm



**41-8009 - Manipulator Mushroom Tipped**  
Tip Angled at 45 Degrees  
Tip L 11mm O/L 123mm



**41-4006 - Spatula Govan**  
Tip Angled at 45 Degrees  
Tip L 10mm O/L 130mm



**41-4003 - Manipulator Phaco Chopper Mackool**  
Tip Angled at 45 Degrees  
Tip L 2mm O/L 120mm



**41-7008 - Chopper Greens Phaco**  
Tip Angled at 45 Degrees  
Tip L 10mm O/L 117mm



**41-7009 - Chopper Claw**  
Tip Angled at 45 Degrees  
Tip L 10mm O/L 123mm



**41-6007 - Paddle Manipulator Drysdale**  
Tip Angled at 45 Degrees  
Tip L 11mm Spatula 1mm O/L 120mm



**41-4005 - Chopper Sadiq**  
Tip Angled at 45 Degrees  
Tip L 11mm O/L 121mm



**41-4004 - Chopper Ambidextrous**  
Tip Angled at 45 Degrees  
Tip L 11mm O/L 115mm



**41-4007 - Haefliger Chopper**  
Tip Angled at 45 Degrees  
Tip L 11mm O/L 115mm



**41-9010 - Manipulator Sinskey/Mushroom Double Ended**  
Tips Angled at 45 Degrees  
Sinskey Tip Length 0.65mm, Mushroom Tip  
O/L 123mm

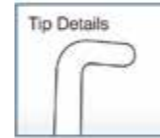

**41-9011 - Manipulator Aycliffe/Sadiq Double Ended Chopper**  
Tips Angled at 45 Degrees  
Tips Lengths 0.5mm and 1.5mm



**41-9012 - Manipulator Mushroom/Sadiq Double Ended**  
Tips Angled at 45 Degrees  
Mushroom Tip, Sadiq Tip Length 1.5mm



**51-0000 - Flap Lifter Lasik - O/L122mm - Tip L12mm**

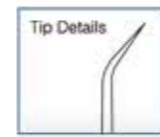

**51-0001 - Epithelial Spatula - O/L113mm - Spatula L7mm**



**51-0002 - Alcohol Well - O/L114mm I/D 9mm**



Refractive

**90-2008 - Probe Liebricht 000+00**  
O/L125mm



**90-2009 - Probe Liebricht 00+0**  
O/L125mm



**90-2010 - Probe Liebricht 1+2**  
O/L125mm



**90-2011 - Probe Liebricht 3+4**  
O/L125mm



**90-1011 - Dilator Punctal Double Ended**  
O/L138mm



**90-1012 - Nettleships Dilator**  
O/L118mm Tip 20mm



**90-8012 - Bulldog Clamp**  
O/L 52mm



**90-9013 - Desmares Retractor**  
14mm Width



**90-7001 - Needle Holder Castroviejo**  
Straight with lock O/L135mm 12mm Tying Platform



**90-7002 - Needle Holder Castroviejo**  
Without lock O/L135mm 12mm Tying Platform



**91-7003 - Needle Holder Castroviejo**  
Delicate Curve O/L135mm 12mm Tying Platform



**91-7004 - Needle Holder Troutman**  
O/L105mm 6mm Tying Platform

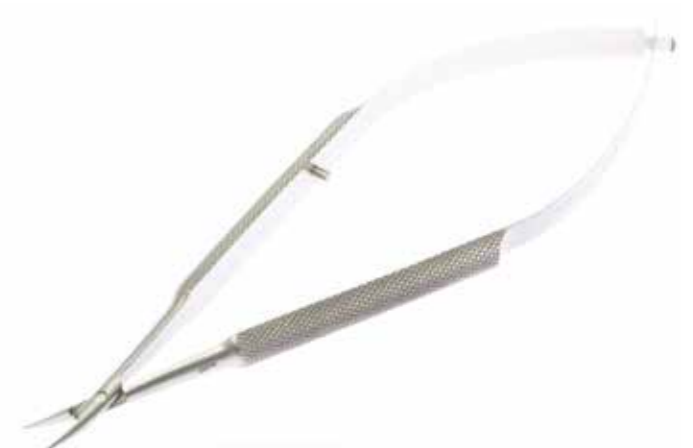

**90-5004 - Hook Stabismus Graefe Medium**  
O/L140mm Tip L10mm



**90-5005 - Hook Alexandra Muscle**  
O/L130mm Tip L11mm

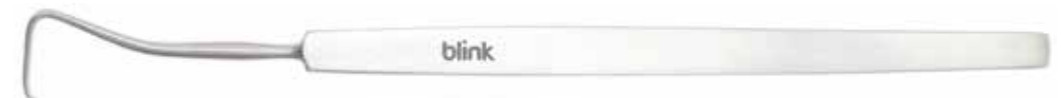



**90-4005 - Clamp Chalazion Small**  
O/L90mm Clamp Diameter 11mm



**90-4006 - Clamp Chalazion Medium**  
O/L80mm Clamp Diameter 18mm x11mm



**90-4007 - Clamp Chalazion Large**  
O/L90mm Clamp Diameter 23mm x15mm



**90-1014 - Caliper and Rule**



**90-1015 - Double Ended Marker**  
3.5 - 4.0mm O/L 113mm

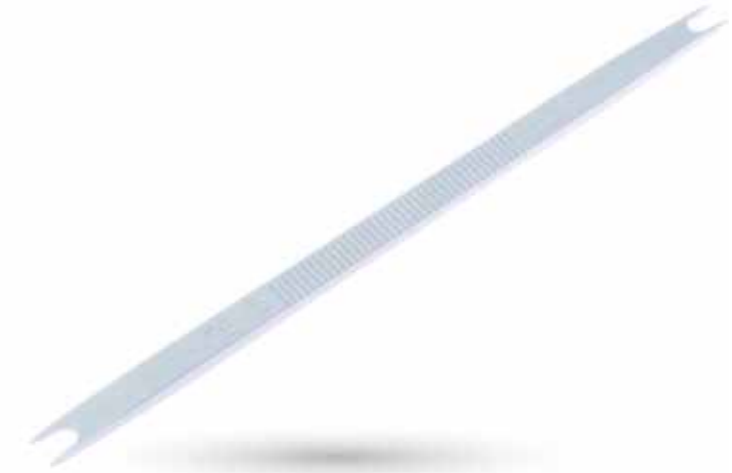

**90-4008 - Desmares Entropian Clamp Left**  
O/L95mm Clamp Diameter 24mm x 16mm



**90-4009 - Desmares Entropian Clamp Right**  
O/L95mm Clamp Diameter 24mm x 16mm



**90-1016 - Marker Fixator**  
3.5mm



**90-1017 - Braunstien Marker**  
3.5 - 4.0mm O/L 80mm



**90-3007 - Curette Double Ended**  
2mm & 3mm cup O/L130mm



**90-3008 - Curette Double Ended**  
2mm & 5mm cup O/L130mm



**90-3009 - Curette Double Ended**  
2mm & 4mm cup O/L130mm



90-8000 - Corneal Trephine 10mm



90-8002 - Corneal Trephine 12mm



90-8004 - Corneal Trephine 14mm



90-8005 - Corneal Trephine 15mm



90-8006 - Corneal Trephine 16mm



90-8007 - Corneal Trephine 17mm



90-1020 - Thornton Ring



91-6000 - Degree Gauge 11.7mm I.D.



91-6001 - Alignment Marker, 3, 6, 9 O'clock.



91-6002 - Toric IOL Marker 11mm



001 - Sub Tenon Set - Standard Tip  
001-A - Sub Tenon Set - Fine Tip



Qty	Code	Description
001		
1	21-4009	Scissors Westcott Curved Standard Tip
1	31-1006	Speculum Kratz-Barraquer Angled Temporal
1	10-1301	Forceps Suture Moorfields
1		Wrap
001A		
1	21-4010	Scissors Westcott Curved Fine Tip
1	31-1006	Speculum Kratz-Barraquer Angled Temporal
1	10-1301	Forceps Suture Moorfields
1		Wrap

270 - CP Sub Tenon Basic Set

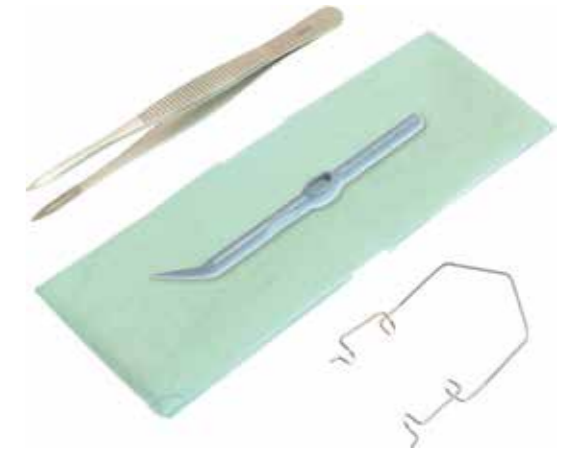

Qty	Code	Description
1	10-1301	Forcep Suture Moorfields
1	31-1006	Speculum Kratz-Barraquer Angled Temporal
1	CP01	Conjunctival Probe
1		Wrap

300 - Complete Sub Tenon Set



Qty	Code	Description
1	10-1301	Forceps Suture Moorfields
1	31-2003	Speculum Barraquer Angled Temporal
1	21-4010	Scissors Westcott Curved Fine Tip
1		Sub Tenon Cannula
1		Syringe 5ml Luer Lock
5		Swab Non Woven 10x10cm
1		Tray with Gallipot Holder
1		Wrap

290 - Complete CP Sub Tenon Set



Qty	Code	Description
1	10-1301	Forceps Suture Moorfields
1	31-1006	Speculum Kratz-Barraquer Angled Temporal
1	CP01	Conjunctival Probe
1		Sub Tenon Cannula
1		Syringe 5ml Luer Lock
5		Swab Non Woven 10x10cm
1		Tray with Gallipot Holder
1		Wrap



023 - Basic Intravitreal Injection Set

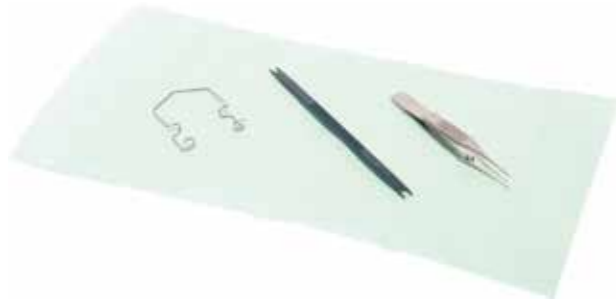

Qty	Code	Description
1	30-1007	Scissors Westcott Curved Fine Tip
1	90-1015	Speculum Kratz-Barraquer Angled Temporal
1	10-1104	Forceps Suture Moorfields
1		Wrap

208-A - Complete Ophthalmic Intravitreal Set



Qty	Code	Description
1	31-2003	Speculum Barraquer Angled Temporal
1	90-1015	Marker Double Ended Scleral
3		Eye Spears
3		Double ended Cotton Buds
1		Plastic Rampley Sponge Holders
1		Drape 40x40cm Slit Incise Drape
1		60ml Gallipot
1		Swab Non Woven 10x10cm
1		Tray with Gallipot Holder
1		Wrap

092 - Chalazion Set - Small Clamp  
111 - Chalazion Set - Medium Clamp



Qty	Code	Description
092		
1	90-4005	Chalazion Clamp Small
1	90-3009	Curette Double Ended Small/Medium
1		No11 Scalpel
1		Wrap
111		
1	90-4006	Chalazion Clamp Medium
1	90-3009	Curette Double Ended Small/Medium
1		No11 Scalpel
1		Wrap

210 - Ophthalmic Suture Removal Set



Qty	Code	Description
1	10-9007	Forceps Tying McPhearson Straight
1	21-6004	Scissors Vannas Curved
1		Wrap

Efficiency in how surgical procedures are prepared for and carried out is of ever increasing importance to our customers...

Hospitals are increasingly being focussed on efficiency savings within all areas, with a high focus on their Theatre Departments. To support this drive for greater efficiency, Blink Medical have developed a range of standard and Custom Procedure Packs.

Our sales team are trained to identify customer needs and suggest which option of Standard or Custom Packs best meets their requirements. The scope of our Custom Procedure Pack offering covers surgical areas such as Ophthalmology, Dermatology, ENT and Cosmetic Surgery.



When specifying a Custom Procedure Pack, our representative will work hand in hand with your clinical staff and procurement teams to develop a specification that delivers the maximum amount of efficiency from utilising a Custom Procedure Pack whilst managing your cost. Blink Medical have in place a wide range of pre-approved components which allows us to specify and deliver new packs in a market leading timeframe.

- Increased Efficiency
- Improved Infection Control
- Cost Control
- Improved Product Traceability
- Clinical Waste Reduction





095 - Punch Biopsy Set



Qty	Code	Description
1	HR121	Forceps Adson Fine Toothed
1	HR125	Forceps Adson Non Toothed 1.5mm
1	HR521	Needles Holder Halsey Smooth
1	20-7002	Scissors Iris Straight 10cm Sharp Tip
5		Swan Non Woven 10x10cm
1		Tray with Gallipot Holder
1		Wrap

185 - Biopsy Set Full



Qty	Code	Description
1	HR519	Halsey Needle Holder Smooth Narrow Jaw
1	HR122	Forceps Adson Toothed 1.2mm
1	HR240	Curved Strabismus Scissors 11sm
1	HR941	Skin Hook Standard 3mm
1	HR300	No3 BP Handle
1	20-7002	Scissors Iris Straight 10cm Sharp Tip
10		Swab Non Woven 10x10cm
1		Aperture Drape
1		Hand Towel
1		Tray with Gallipot Holder
1		Wrap

038 - Minor Ops Set (A)



Qty	Code	Description
1	HR519	Halsey Needle Holder Smooth Narrow Jaw
1	HR300	No3 BP Handle
1	10-1302	Forceps Utility Lister
1	20-7002	Scissors Iris Straight Sharp 10cm
1	10-1006	Forceps Mosquito Straight
5		Swab Non Woven 10x10cm
1		Aperture Drape
1		60ml Gallipot
1		Hand Towel
1		Tray with Gallipot Holder
1		Wrap

020 - Minor Ops Set (B)



Qty	Code	Description
1	HR121	Forceps Adson Fine Toothed
1	HR125	Forceps Adson Non Toothed 1.5mm
1	HR301	Barron BP Handle
1	HR281	Scissors Steven Tenotomy
1	HR527	Needle Halsey Smooth Neiverts Handle
1	20-7002	Scissors Iris Straight Sharp 10cm
5		Swab Non Woven 10x10cm
1		Drape Sheet 50x60cm
1		Hand Towel
1		Tray with Gallipot Holder
1		Wrap

074 - Excision Set



Qty	Code	Description
1	HR121	Forceps Adson Fine Toothed
1	HR521	Needles Holder Halsey Smooth
1	HR301	Barron BP Handle
1	HR940	Skin Hook Fine 2mm
1	HR283	Scissors Tenotomy Curved Smooth Jaw
1	HR400	Forcpes Mosquito Curved 13cm
10		Swab Non Woven 10x10cm
1		Aperture Drape
1		Hand Towel
1		Tray with Gallipot Holder
1		Wrap

039 - Excision Set Full



Qty	Code	Description
1	HR121	Forceps Adson Fine Toothed
1	HR125	Forceps Adson Non Toothed 1.5mm
1	HR300	No3 BP Handle
1	HR940	Skin Hook Fine 2mm
1	HR519	Halsey Needle Holder Smooth Narrow Jaw
1	HR240	Curved Strabismus Scissors 11sm
1	HR250	Scissors Dressing Stitch Sharp/Blunt
1	20-7002	Scissors Iris Straight Sharp 10cm
1	10-1006	Forceps Mosquito Straight
1	10-1302	Forceps Utility Lister
5		Swab Non Woven 10x10cm
1		Aperture Drape
1		60ml Gallipot
1		Hand Towel
1		Tray with Gallipot Holder
1		Wrap

047 - Minor Ops Set Full



Qty	Code	Description
1	HR122	Forceps Adson Toothed 1.2mm
1	HR940	Skin Hook Fine 2mm
1	HR283	Scissors Tenotomy Curved Smooth Jaw
1	HR400	Forcpes Mosquito Curved 13cm
1	HR300	No3 BP Handle
1	HR521	Needles Holder Halsey Smooth
1	20-7002	Scissors Iris Straight Sharp 10cm
1	10-1302	Forceps Utility Lister
10		Swab Non Woven 10x10cm
1		Aperture Drape
1		60ml Gallipot
1		Hand Towel
1		Tray with Gallipot Holder
1		Wrap

263 - Carpel Tunnel Set



Qty	Code	Description
1	HR122	Forceps Adson Toothed 1.2mm
1	HR301	Barron BP Handle
1	HR521	Heedle Holder Halsey Smooth
1	HR240	Curved Strabismus Scissors 11sm
1	HR703	Dissector Mcdonald
1	HR951	Rampley Sponge Holder
1	HR283	Scissors Tenotomy Curved Smooth Jaw
1	HR700	Retractor Kilner Catspaw
5		Swab Non Woven 5x5cm
1		Tray with Gallipot Holder
1		Wrap



**066 - Suture Removal Set**



**252 - Perio Probe Dental Set**



**HR100 - Forceps Angled at 45° Jewellers**  
3mm tip O/L 110mm  
**HR101 - Forceps Angled at 45° Jewellers**  
7mm tip O/L 110mm



**HR110 - Forceps Gillies Toothed**  
21mm Tying Platform O/L 110mm



Qty	Code	Description
1	20-7002	Scissors Iris Straight Sharp 10cm
1	HR125	Forceps Adson Non Toothed 1.5mm Wrap

Qty	Description
1	Peridontal Probe
1	Right Angled Probe
1	Dental Mirror
1	Dental Forcep
1	Wrap

**HR111 - Forceps De Bakey Toothed**  
20mm Tying Platform O/L 150mm



**HR120 - Forceps Adson Toothed**  
Dissecting 1.7mm Teeth O/L 120mm  
**HR121 - Forceps Adson Toothed**  
Dissecting 0.8mm Teeth O/L 120mm  
**HR122 - Forceps Adson Toothed**  
Dissecting 1.2mm Teeth O/L 120mm



**R001 - Dental Examination Set**



**R003 - Dental Measuring Set**



Qty	Description
1	Dental Mirror
1	Dental Explorer
1	Tweezers

Qty	Description
1	Dental Mirror
1	Dental Explorer
1	Ruler

**HR125 - Forceps Adson Non-Toothed**  
O/L 120mm



**HR126 - Forceps Adson Brown**  
O/L 120mm



**HR127 - Forceps Assistant Delicate**  
11mm Tying Platform O/L 115mm



Forceps

**HR130 - Forceps Iris 11cm Serrated**  
15mm Tying Platform O/L 113mm



**HR131 - Forceps Epilation Angled**  
21mm Angled Tips O/L 91mm



**HR200 - Scissors Iris Straight**  
Sharp Tip 100mm O/L



**HR210 - Scissors Iris Curved**  
Sharp Tip O/L 100mm



**HR160 - Forceps Allis Tissue Tying 15cm**  
5:4 Teeth O/L 150mm



**HR150 - Forceps McIndoe 15cm**  
18mm Tying Platform O/L 155mm



**HR240 - Scissors Strabismus Curved**  
Rounded Tip O/L 115mm



**HR241 - Scissors Strabismus Straight**  
Rounded Tip O/L 115mm



**HR143 - Forceps Watch Maker No.7**  
13mm Tip O/L 115mm



**HR161 - Forceps Dissecting TOE 12.5cm**  
18mm Serrated Tip O/L 127mm



**HR250 - Scissors Dressing Stitch 15cm**  
Sharp/Blunt Tip  
**HR251 - Scissors Dressing Stitch 13cm**  
Sharp/Blunt Tip



**HR261 - Scissors Mayo Curved**  
Rounded Tip O/L 185mm





**HR262 - Scissors Mayo Straight**  
Rounded Tip O/L 140mm



**HR270 - Scissors Metzemaum Curved 18cm (McIndoe)**  
Rounded Tip O/L 175mm



**HR300 - Handle Scalpel BP No.3**  
Rounded End O/L 125mm



**HR301 - Handle Barron BP No.3**  
O/L 135mm



**HR271 - Scissors Metzemaum Straight**  
Rounded Tip O/L 180mm



**HR272 - Scissors Aufricht Curved**  
Curved sharp tip O/L 160mm

New



**HR280 - Scissors Straight**  
Sharp Tip O/L 125mm



**HR400 - Mosquito Curved**  
O/L 130mm



**HR420 - Mosquito Straight**  
O/L 130mm

**HR405 - Mosquito Curved**  
O/L 90mm

**HR410 - Mosquito Straight**  
O/L 90mm



Mosquitos

**HR281 - Scissors Steven Tenotomy Straight**  
Sharp Tip O/L 110mm



**HR282 - Scissors Steven Tenotomy Curved**  
Supercut O/L 125mm



**HR283 - Scissors Steven Tenotomy Curved**  
Sharp Tip O/L 106mm



Should you have an idea for new single use surgical device, our in house design team would be happy to speak to you to see if we can turn it into reality. Please contact us at [sales@blinkmedical.com](mailto:sales@blinkmedical.com)

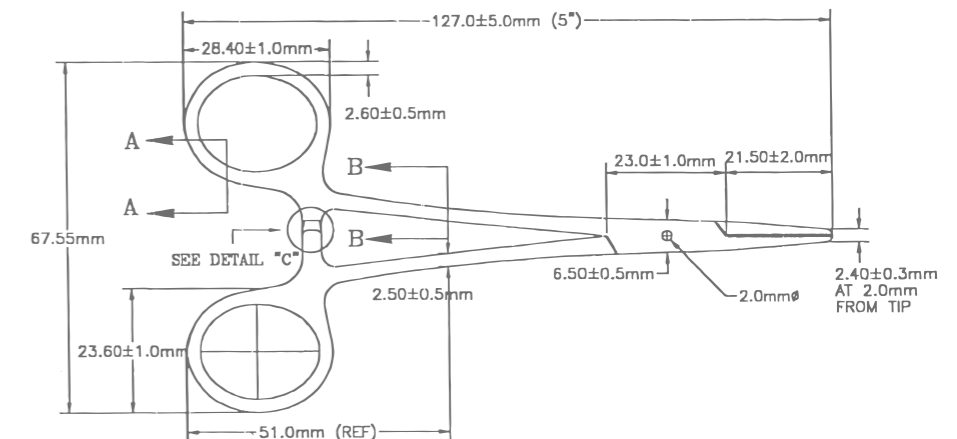

**HR500 - Needle Holder Mayo**  
O/L 150mm

**HR526 - Needle Holder Parkhouse**  
Angled Thumb Grip O/L 130mm

**HR510 - Needle Holder Crilewood**  
O/L 130mm

The **Blink Medical** BiPolar range has now been increased to reflect the popularity of this instrument. The forceps which come complete with their leads offer a cost effective disposable alternative to the traditional reusable instrument. All forceps in the range are produced from the highest quality components and each one goes through multiple inspections here in the UK along with a comprehensive electrical test which ensures complete safety and efficacy.

**HR630 - BiPolar McPhearson**  
Straight with Lead O/L 110mm with universal connectors



**HR519 - Needle Holder Halsey**  
Smooth / Fine O/L 130mm

**HR527 - Needle Holder Halsey**  
Smooth Angled Thumb Grip O/L 130mm

**HR520 - Needle Holder Halsey**  
O/L 130mm

**HR600 - BiPolar McPhearson**  
Straight with Lead O/L 110mm

**HR601 - BiPolar McPhearson**  
Straight with Lead O/L 200mm



**HR521 - Needle Holder Halsey**  
Smooth O/L 130mm

**HR522 - Needle Holder Kilner**  
O/L 130mm

**HR523 - Needle Holder Neiverts**  
O/L 130mm

**HR602 - BiPolar Adson Straight**  
with Lead O/L 150mm

**HR603 - BiPolar Bayonet**  
with Lead O/L 190mm





**HR700 - Retractor Catspaw Kilner**  
8mm Claw Diameter O/L 150mm



**HR703 - Dissector McDonald**  
O/L 195mm



**HR820 - Towel Clip Ball & Socket**  
O/L 100mm



**HR800 - Towel Clip Backhaus**  
O/L 95mm



**HR704 - Retractor self retaining**  
West (Sharp) O/L 135mm

**HR708 - Retractor self retaining**  
West (Blunt) 2:3 Teeth O/L 130mm

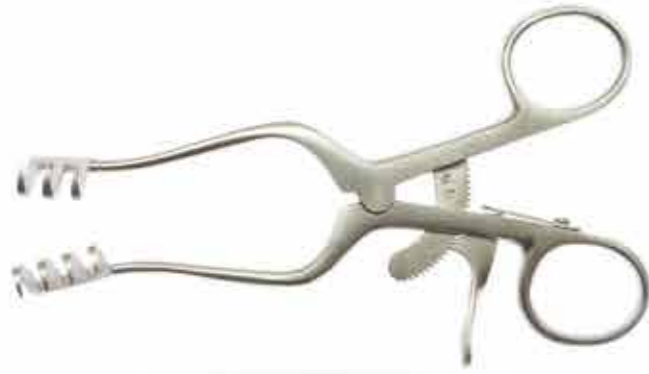

**HR776 - Hook Cawthorne**  
O/L 150mm



**HR949 - Sponge Holder Rampley**  
O/L 240mm



**HR951 - Sponge Holder Rampley**  
O/L 180mm



**HR777 - Retractor Catspaw Mini**  
5mm Claw Diameter O/L 165mm



**HR939 - St Bart's Hook**  
O/L 170mm



**HR940 - Skin Hook Fine**  
2mm Hook O/L 165mm  
**HR941 - Skin Hook Standard**  
3mm Hook O/L 165mm  
**HR942 - Skin Hook McIndoe**  
5mm Hook O/L 165mm



**HR181 - Forcep Bonney Polypus**

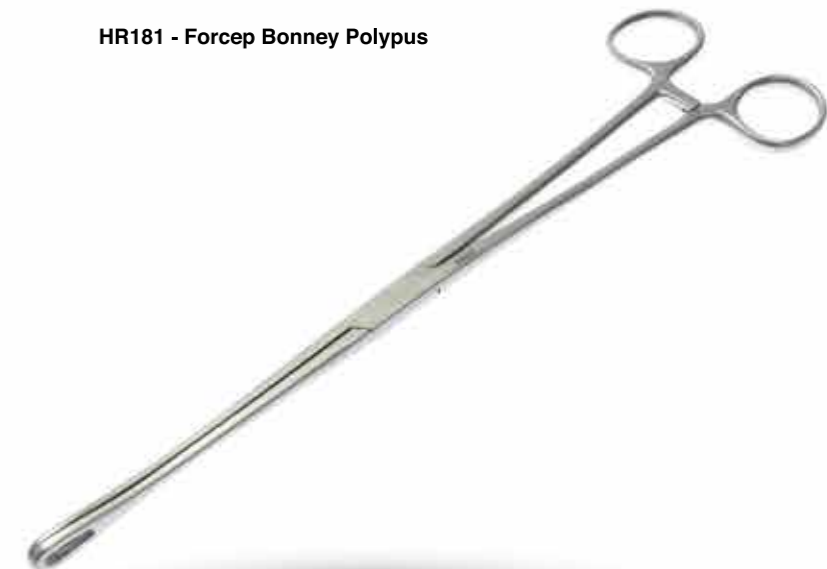

**HR608 - Cannula Fat Removal** V Shaped 9cm 1.5mm



**HR609 - Cannula Fat Injection** 9cm x 2mm



**HR610 - Cannula Fat Injection** 9cm x 1.5mm



**HR611 - Cannula Fat Injection** 12cm x 1.5mm



**HR612 - Cannula Fat Harvest** 15cm x 3mm



**HR613 - Cannula Infiltration** 30cm x 2.5mm, 10 ports, spiral pattern



**HR614 - Cannula Infiltration** 15cm x 2.5mm, 10 ports, spiral pattern



**HR615 - Cannula Infiltration** 20cm x 2mm, 10 ports, spiral pattern



**HR616 - Cannula Infiltration** 15cm x 2mm, 10 ports, spiral pattern



**HR617 - Cannula Infiltration** 10cm x 2mm, 10 ports, spiral pattern



All Blink Medical Lipo Cannulae are fitted with a Mercedes style tip and come in a variety of different lengths and diameters.

**HR620 - Cannula Liposuction** 30cm x 6mm



**HR621 - Cannula Liposuction** 30cm x 5mm



**HR622 - Cannula Liposuction** 30cm x 4mm



**HR623 - Cannula Liposuction** 30cm x 3mm



**HR624 - Cannula Liposuction** 15cm x 4mm



**HR625 - Cannula Liposuction** 15cm x 3mm



**HR626 - Cannula Liposuction** 15cm x 2mm



**HR643 - Cannula Liposuction** 22cm x 3mm - Luer Lock





**HR100 - Forcep Angled Jewellers**  
3mm Tip O/L 110mm

**HR101 - Forcep Angled at 45° Jewellers**  
7mm Tip O/L 110mm



**HR140 - Forcep Straight**  
Serrated Tip 8mm O/L 95mm



**HR710 - Fine Croc Forceps**  
6mm x 1.3mm Jaw



**HR711 - Forceps Tilley Nasal**  
20mm Serrated Jaw



**HR141 - Forcep Angled Serrated Cutting**  
Serrated Tip 7mm O/L 95mm



**HR142 - Forcep Jewellers No.5**  
O/L 110mm



**HR714 - Scissors Crocodile**



**HR716 - Extra Fine Croc Forceps, Black Coating**  
6mm x 1.2 jaw



**HR143 - Forcep Watch Maker No.7**  
13mm Tip O/L 115mm

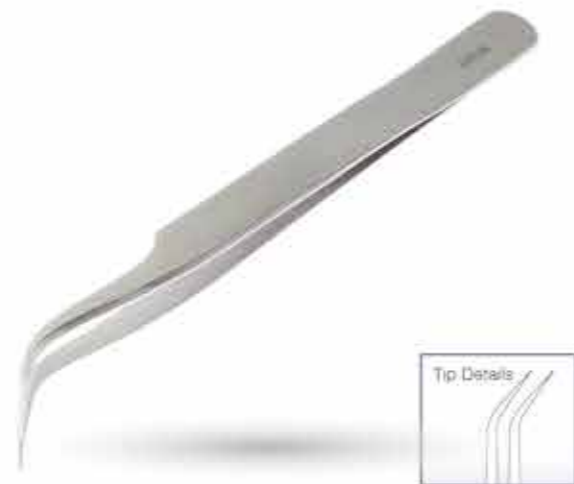

**HR715 - Extra Fine Croc Forceps**  
5mm x 1.2mm Jaw



**HR761 - Forceps Troilettsch**  
Small 5'



**HR722 - Ear Speculum 2mm**  
Plastic non sterile bag 100

**HR723 - Ear Speculum 3mm**  
Plastic non sterile bag 100

**HR724 - Ear Speculum 4mm**  
Plastic non sterile bag 100

**HR725 - Ear Speculum 5mm**  
Plastic non sterile bag 100

**HR726 - Ear Speculum 6mm**  
Plastic non sterile bag 100

**HR727 - Ear Speculum 7mm**  
Plastic non sterile bag 100



**T013 - Ear Speculum 2mm**

**T014 - Ear Speculum 3mm**

**T015 - Ear Speculum 4mm**

**T016 - Ear Speculum 5mm**

**T017 - Ear Speculum 6mm**

**T018 - Ear Speculum 7mm**



**HR753 - Lempert Suction**  
2mm O/D



**HR755 - Yankaure Suction Tube**



**HR740 - Tongue Depressor**



**HR730 - Thudichum Small**  
**HR731 - Thudichum Medium**  
**HR732 - Thudichum Large**



**HR756 - Fraiser Suction Tube**  
4mm O/D



**HR750 - Zoellner Suction Tube**  
Includes 20g Tip and Trocar



**HR751 - Jobson Horne Probe**  
125mm O/L

**HR752 - Jobson Horne Probe 7"**  
185mm O/L



**HR763 - Formby Cerumen Scoop and Hook**



**HR830 - Curette Volkmann 5mm / 6mm cups**



**HR950 - Dental Syringe**



**HR720 - ENT Mirror**  
25mm Mirror Diameter











# blink<sup>o</sup>medical

the single-use instrument company



[twitter.com/BlinkMedical](https://twitter.com/BlinkMedical)



[www.facebook.com/blinkmedical](https://www.facebook.com/blinkmedical)



[www.linkedin.com/company/blink-medical/](https://www.linkedin.com/company/blink-medical/)

## **Blink Medical Ltd**

Radway Road  
Shirley  
Solihull  
B90 4NS

Tel: **+44 (0) 121 386 8433**

Fax: **+44 (0) 121 277 4949**

Web: **[www.blinkmedical.com](http://www.blinkmedical.com)**



Version 5.0